

# Connected



*Cincinnati Bell*  
**Fioptics**  
513-565-9890



Welcome to Cincinnati Bell and thank you for choosing us. Using the very best in advanced network technology, we're able to bring you all the entertainment, information and communication you need at the speed of light. This book has been created to give you a glimpse of what your new Cincinnati Bell products can do for you.

### **Fioptics TV**

Cincinnati Bell's Digital TV service delivers more than 300 digital channels, HD, digital music channels, DVR service and On Demand. There's incredible entertainment everywhere you turn.

### **Fioptics Internet**

You can enjoy download speeds up to 100Mbps. Even during peak times, your Internet connection is hands down the fastest in town.

### **Fioptics Voice**

We have more than 14 unique calling services to meet your needs, and plans that allow you to call anywhere, anytime in the United States.

### **Wireless**





Flexible rate plans, a wide assortment of wireless phones and accessories, international coverage and no contracts make Cincinnati Bell the ideal choice for your wireless phone needs.

### **Bundles**

Our services are all great on their own. But when you bundle them together, the convenience and savings you get are unbeatable.

Thanks again for choosing Cincinnati Bell. We're happy to have you as a new customer and look forward to providing you with exceptional services.

Sincerely,  
Michael Morrison, Director, Fioptics Services

 <b>Fioptics TV</b>	<b>3</b>
● Remote	4
● Set-Top Box	5
● Interactive Program Guide (IPG)	6
 <b>Fioptics Internet</b>	<b>10</b>
● Internet Security	10
● Email Setup	11
 <b>Fioptics Voice</b>	<b>12</b>
● Voicemail	12
● Calling Services	13
 <b>Wireless</b>	<b>14</b>
● Fusion WiFi	14
● Phones	15
 <b>Support</b>	<b>16</b>
● My Account	16
● Troubleshooting	17
● Legal	18
● Contact Us	23

# Fioptics TV entertainment wherever you turn

**Get an almost endless array of entertainment right at your fingertips.** Movies, music, sports, news, documentaries, kids' programs—plus plenty of programs in the unrivaled beauty of HD at your command On Demand.

## HD

Enjoy a theater experience without leaving home! You'll have access to nearly 60 popular HD channels for FREE, including:

- National Geographic HD
- HGTV HD
- ESPN HD
- CNN HD

If that's not enough, you can add even more HD programming with our Premium Tier.

## On Demand

Save a trip to the video store by choosing from thousands of hours of entertainment at the touch of a button.

- Free On Demand
- Kids On Demand
- Movies On Demand
- Premiums On Demand

## DVR

Be sure to never miss a moment of your favorite show, and even pause and rewind live TV!

- Record 2 shows while watching something you previously recorded
- Record the shows you like by genre, actor or director
- Record an entire season of your favorite series

## Premium Channels

From blockbuster movies to original comedy, premium channels provide the best in entertainment.

- HBO
- Showtime
- Starz
- Cinemax
- The Movie Channel
- Encore

## Sports

You are always in the game with Fioptics TV. There is no need to miss a minute of action, no matter what sport you enjoy. For even more sports content, add the Fioptics Sports Package.

- CBS College Sports
- MLB Network
- TVG, and more!

## International

With the Spanish Tier, enjoy the most popular Spanish-language channels, including a variety of movies, music, sports and children's entertainment.

- Mun2
- Telemundo
- Discovery en Español
- Cine Mexicano
- ESPN Deportes
- Discovery Familia, and more!

Cincinnati Bell provides a variety of options for Indian programming.

- Zee TV
- Star India Plus
- Star One
- Star India Gold



# FEATURES OF YOUR REMOTE

**LIST** Access and manage DVR recordings.

**REPLAY** Replay the last 15 seconds of a recorded program or live TV with DVR.

**MENU** Access settings, favorites, parental controls and recordings.

**GUIDE** See TV Listings for the current time.

**DAY +/-** Jump ahead or back 24 hours in TV Listings.

**ARROWS** Navigate through the program guide and menu screens.

**NUMBERS** Press channel numbers to directly tune to a channel.

**SWAP** Swap between the two picture-in-picture screens.

\* Switch input mode to alphabet input.

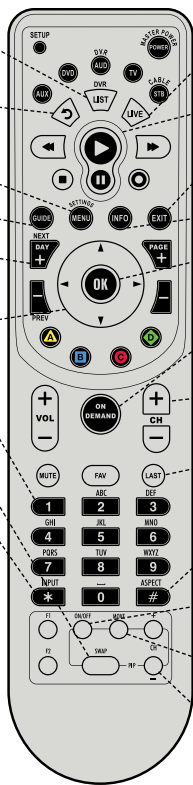

**LIVE** Jump to live TV when using DVR.

**VCR CONTROLS** Control On Demand and DVR, where available.

**EXIT** Return to watching television.

**INFO** View current program information.

**OK** Confirm highlighted selections.

**ON DEMAND** Directly access On Demand movies and TV programs.

**CH +/-** Change channel to the next higher or lower channel.

**LAST** Return to previous channel or menu when viewing the guide or menu.

**#** Change the aspect ratio (4:3 or 16:9) on set-top box.



**ON/OFF** Access picture-in-picture mode.

**MOVE** Move the location of the picture-in-picture window.

**CH +/-** Change the channel of the picture-in-picture window.

## PROGRAMMING INSTRUCTIONS

During installation your Cincinnati Bell technician programmed your remote. If your remote control stops working with your set-top box, remove any obstructions between the remote and set-top box, press  and try again.

If that doesn't work, you can re-synchronize the remote by pressing  +  for 3 seconds.

If you have a different remote please visit [www.urcsupport.com](http://www.urcsupport.com).



# HOOK UP YOUR SET-TOP BOX

Chances are one of our top-notch technicians already installed your Fioptics TV service for you. In case you decided to install it yourself or if you choose to move your TV equipment to another spot in the room, the diagram below spells out how to connect the appropriate cables. You will need a separate set-top box for each TV on which you wish to receive digital services. In order to receive HD programming, you must have an HD set-top box.

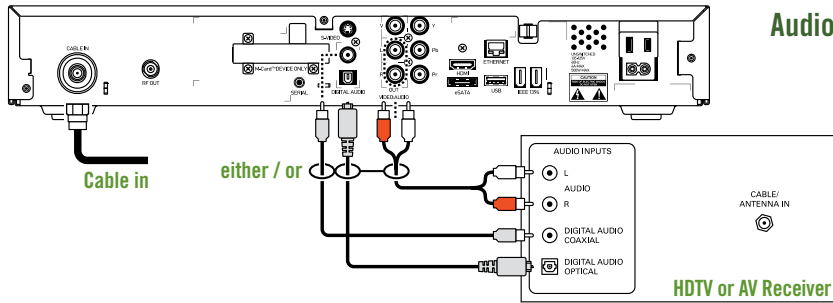
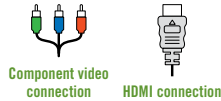
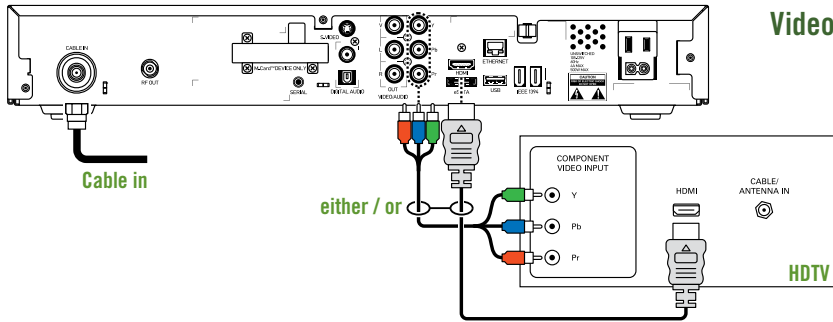

## QUICK TIP

If your set-top box does not turn on, it may be updating. Wait a few minutes and try again. If that doesn't work, check that the power cord is plugged in and the outlet is working.

# ACCESS YOUR INTERACTIVE PROGRAM GUIDE (IPG)

## Settings

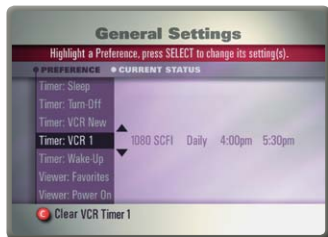

### General and quick settings

The General and Quick Settings menus are portals to your IPG.

- Press **MENU** twice to access the General Settings or once to access the Quick Settings
- Press the **◀▶** buttons to move through the shortcuts
- Press **OK** to select the highlighted item
- To return to watching TV, press **EXIT**

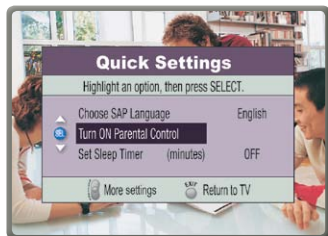

### Quick settings options

- Turn ON/OFF Parental Control
- Picture Size
- Caption OFF/ON or On With Mute
- Choose Language
- Start Recording (Current Channel) Now
- Start Sleep Timer (Minutes)
- Add/Remove from Favorites List

## Channel Banner



The Channel Banner appears every time you change channels to make it easy to see what's on now. The current channel, program name, rating and start and end times are conveniently displayed.

- Press **CH** **+** **-** to change channels and display the Channel Banner
- Press **OK** to make the Channel Banner disappear and reappear
- Press **INFO** for additional program details

*Menu selection may vary. The set-top box you received is based on where you live. Boxes are not interchangeable.*



## TV Listings



### Search by time or channel

View start times, titles, ratings and descriptions.

- Press **GUIDE** and select **TV Listings**
- Use **▼▲** to navigate by channel and **◀▶** to navigate by time
- Press **OK** to view a current program or set a timer for a future program



### Search by theme

View program listings by theme, such as **News** or **Sports**.

- Press **GUIDE** and then **▲**
- Use the **▼▲** buttons to select a theme and press **OK**
- Press **EXIT** to return to the last channel you were viewing

## QUICK TIP

Select the HDTV theme to search for HD content or refer to the HD channels listed in your channel lineup. Only programming that is produced in HD and delivered via an HD channel will be shown in HD.

## Add or remove favorites

Set up a favorites list for easy access to your favorite channels and programs.

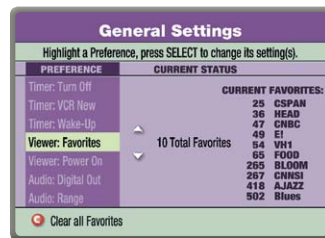

- Select **Add/Remove from Favorite List** in Quick Settings
- As you scroll through the channels, press **FAV** to select or deselect your favorite channels
- Press **EXIT** to return to the last channel you were viewing or press **LAST** to return to the General Settings

## Access your favorites

- Press **FAV** while watching TV to change to your next favorite channel
- Press **FAV** while looking through the channel listings to highlight your next favorite channel

## DVR

A DVR offers you a whole new way to watch TV—giving you the convenience and control to watch your favorite shows according to your schedule. Your DVR utilizes features similar to those found on your DVD player—just press **▶**, **⏸**, **⏹**, **◀** or **▶** on your remote. You can even record one program while you watch another!



### Record a program

You have two different ways to record a program:

- Press **Ⓞ** while watching TV or viewing your TV listings
- Press **Ⓜ** and select

### Start Recording (Current Channel) Now



### Watch a recorded program

- Press **Ⓛ** to access a list of your recorded programs
- Highlight the program you want to watch using the **▲**/**▼** buttons and press **Ⓞ**
- Press **▶** when you are ready to begin viewing the program
- Press **Ⓛ** to return to live TV

## On Demand

On Demand gives you the convenience of watching what you want when you want using DVD-like controls.



### Access On Demand

- Press **Ⓞ**
- Use the **▲**/**▼** buttons to scroll through the available categories and press **Ⓞ**
- Pick out a program to watch and press **Ⓞ**

### QUICK TIP

Record up to 90 hours of SD or 20 hours of HD programming. Ensure that your favorite programs aren't deleted by designating that those programs can only be deleted manually.

### QUICK TIP

Many On Demand programs are free, while others are comparably priced to the fees that your local video rental store charges.



## Parental Controls

With the increased variety of programming available on digital cable, there's also some fare that, quite frankly, isn't appropriate for children. But don't worry, we've included an integrated parental control feature as part of your system.

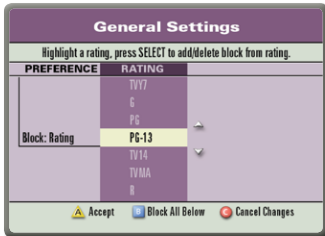

### Set parental controls

- In General Settings, select **Block: Channels**; **Block: Rating**; or **Block: Time New**, and press **OK**
- Enter your 4-digit Locks PIN and follow prompts
- Press **EXIT** to return to the last channel you were viewing or press **LAST** to return to General Settings

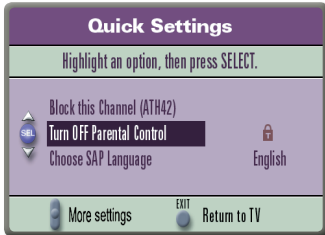

### Turn controls on and off

- Select **Turn ON Parental Control** or **Turn OFF Parental Control** in Quick Settings and press **OK**
- Enter your PIN and press **OK**



### Set purchased program locks

Your Purchase PIN is different from your Locks PIN. Please call our customer service department if you wish to use this option and do not have the Purchase PIN option listed.

- To restrict purchase of On Demand and Pay-Per-View programming, select **Purchase: PIN** in General Settings and press **OK**

### QUICK TIP

For assistance setting up parental controls or disabling VOD content, please contact Technical Support at 513-565-9890.

# Fioptics Internet

## information at your fingertips

**The world's on the move and so are you—get there with amazing Internet performance.** With Fioptics Internet, you get lightning-fast speeds of up to 30Mbps, 10GB of backup and storage automatically included, and an all-in-one protection package. Now that's something!

### Features

Cincinnati Bell has the fastest download speeds in town, so you can do even more in less time. With our 30Mbps package you can upload up to 40 photos in just 1 minute, or download 4 songs in the same amount of time it would have taken to download 1 song on cable Internet.

Our wireless modems and routers can support up to 4 wired devices and 32 wireless devices, so you can hook up the whole family! Connect any WiFi-enabled device (iPad, iPhone, laptop, WiFi phone, etc.) automatically, without any additional equipment.

Plus, you have access to tons of additional features for FREE:

- FREE access to over 350 WiFi Hot Spots throughout the Cincinnati area
- FREE month of Internet security

### QUICK TIP

If your connection or download speeds seem slow, try waiting awhile for them to improve before rebooting your computer and/or modem.

### Internet Security

The protection package provides enterprise-level security for homes and small offices, with personal customization features for your family or small business. F-Secure provides round-the-clock defense against these attacks.

- **Anti-Virus and Anti-Spyware:** Stops viruses, worms, and other unknown attacks in real time. Hit the Information Superhighway without the fear of your information being sent to third parties.
- **Firewall Protection:** Increases privacy and thwarts potential identity theft and Internet fraud by protecting both your PC and your data against hackers.
- **Web Filtering and Parental Controls:** Allows parents to better monitor and limit the types of material that can be accessed or viewed when children are online.
- **Anti-Spam:** Examines all inbound emails and filters junk email from important email, then places them in a folder for review or automatically deletes them.
- **Automatic Updates:** Updates your entire security suite anytime you are connected to the Internet—you won't know they're going on and they won't interrupt what you're doing one bit.



## System Requirements

Currently, we support the following:

- Web browsers: Internet Explorer 6.0+, Firefox 1.5+ and Safari
- Operating systems: Windows 2000, XP, 7 or Vista, and Mac OS X
- Processor: minimum Intel Pentium 600MHz
- Available hard-drive space: 320MB

While other browsers and operating systems should work with our network, Cincinnati Bell does not provide technical support for them at this time.

## Set Up Email

Now that you've got the best Internet in town, it's really easy to set up your new email account:

1. Go to <http://webmail.fuse.net>
2. Enter your email address and password

To add up to 4 additional email addresses or change your password:

1. Go to <http://webmail.fuse.net>
2. Click **Maintain Account**
3. Enter your primary email address, password and the security code shown onscreen

### QUICK TIP

Our servers will allow you to send a file, or group of files, in a single email that collectively add up to a maximum of 10MB.

## Online Backup and Storage

This easy-to-use all-in-one service allows you to upload, store and protect your treasured photos, documents, music and videos. Access your files from anywhere online.

- Download our software to set up automated backups on your PC
- Upload your files to the cloud using our simple web interface—up to 10GB is FREE
- If you run out of space, you can upgrade your data at any time

## TrueSwitch

TrueSwitch makes switching to Fioptics Internet simple, easy and fast by:

- Copying all your personal data to your new account
- Notifying everyone in your address book about your new email address
- Forwarding emails sent to your old email address
- Helping you cancel your old ISP account

Even better—TrueSwitch from Cincinnati Bell is FREE!

# Fioptics Voice

## communication that's right at home

**Stay connected with our voice service and get all the features you could want.** When it comes to award-winning customer satisfaction and the most experienced, local technicians, there's no provider like Cincinnati Bell Fioptics.

### Make Calls

**Local:** Dial the 7- or 10-digit telephone number

**Long Distance:** Dial 1 + area code + 7-digit telephone number

**International:** Dial 011 + country code + telephone number

**Operator Assistance:** Domestic: Dial 0, International: Dial 00

Please note that charges may be assessed on a per-use basis and are dependent on the services provided. Airtime costs after the call has been connected will be billed separately.

**Directory Assistance:** Dial 411

Charges will be assessed on a per-use basis.

**Emergency:** Dial 911

### Battery Backup

Fioptics Voice customers are supplied with a battery backup system to provide up to 8 hours of service during a power outage.

- Typical batteries last several years (we'll contact you when your battery needs to be replaced)
- Replacement batteries can be purchased at any Cincinnati Bell store

### Voicemail

#### Set up your voicemail

1. Dial the access number:  
Greater Cincinnati (OH and IN): 513-554-1234  
Greater Cincinnati (KY): 859-392-1234  
Greater Dayton, Middletown and Springfield: 937-619-1234
2. Enter your 10-digit telephone number
3. Enter your temporary password, 1111
4. Listen to the New Subscriber Tutorial, an automated lesson in setting up your mailbox

#### Access your voicemail

1. Dial \*966 or \*11
2. Enter your password and press #

If you have purchased Cincinnati Bell's Per-Line Privacy feature, dial \*82 plus the access number to release your number to the voicemail system.

#### QUICK TIP

You'll know that you have new voicemail messages when you pick up the phone and hear a stutter dial tone instead of a solid dial tone.



## Vicemail main menu

- To listen to new messages, press 11
- To listen to saved messages, press 12
- To change your greetings, press 43

## Calling Services

**Anonymous Call Rejection:** Block all incoming calls marked as Private or Anonymous. To activate: \*77. To deactivate: \*87.

**Anywhere Call Forwarding:** Remotely forward calls to any phone. To activate and deactivate, call 513-421-7869. Enter your 10-digit phone number and password (temporary password defaults to 0042), and follow prompts.

**Call Block:** Block unwanted calls from phone numbers you select. To activate: \*60. To deactivate: \*60.

**Call Forwarding:** Forward all incoming calls to the local or long-distance number of choice, designating a new number each time you forward your calls. To activate: \*72, listen for dial tone, dial desired forwarded number and listen for 2 short beeps. To deactivate: \*73.

**Call Return:** Dials the last number that called your line. To activate: \*69.

**Call Waiting:** Put a caller on hold to answer an incoming call. Press the receiver to put the first call on hold and take the second call. To activate (one-time only): \*70.

**Caller ID:** The caller's name and number will appear on your Caller ID unit, which is available from Cincinnati Bell or wherever you buy phone equipment.

**Distinctive Ring:** Identify preselected callers with a distinctive ring or call-waiting tone.

- Cincinnati Bell will assign you new telephone numbers. You decide how you want to use them.
- Notify callers of your new telephone numbers.
- Have a friend call so you can recognize the new ring for that number.

**Priority Call:** Select up to six telephone numbers from which incoming calls will cause the phone to ring in a special way. To activate: \*61.

**Repeat Dial:** Automatically redial a number for up to 30 minutes until the call gets through. To activate: \*66.

**Speed Calling:** Quickly call friends and family. Press \*75 and enter a 2-digit code (20-49) after hearing the dial tone. Then dial the complete number that you wish to assign. To use, dial the 2-digit code you assigned followed by #.

**Reveal:** Stops calls marked unidentified by Caller ID before they reach you and asks callers to input their phone number.

**Three-Way Calling:** Talk to two different parties at the same time.

### QUICK TIP

For assistance, call Technical Support at 513-565-9890.



# Wireless always in touch on the go

**So get with the plan that's as mobile as you are.** No two customers' wireless needs are the same, which is why at Cincinnati Bell, we offer a wide variety of affordable voice and data plans with no contracts. So you can select the plan that perfectly fits the way you use your wireless phone service.

## Messaging and Media Plans

Talking is just the tip of the iceberg. Want to use your wireless to share photos, download ringtones, play games, get Info On Demand, check movie times and email away? We've got the perfect plans for multitaskers like you:

- Individual Plans
- Shared Plans
- Unlimited Plans
- Smartphone Plans
- Prepaid Plans

## Fusion WiFi

With Fusion WiFi, your wireless phone connects to both wireless and WiFi signals at home, at work and at more than 300 Cincinnati Bell ZoomTown WiFi Hotspots all over town, giving you outstanding reception, call clarity and faster downloads for FREE! And now you have access to select non-secured Hot Spots across the globe:

- Argentina
- Australia
- Belgium
- Brazil
- Canada
- China
- France
- Germany
- Hong Kong
- Italy
- Mexico
- Norway
- Philippines
- Singapore
- Spain
- Sweden
- Switzerland
- Thailand
- United Kingdom

## Applications

Think of your phone as more than just a phone? We've got lots of ways to let your mobile multi-task.

- Ringtones
- Graphics
- Mobile Alerts
- Voice2Text
- Cellfire Coupons
- Snapfish
- Mobile Email
- Games

## Mobile Broadband

With 4G speeds that are twice as fast as other national carriers\*, you can be assured that you are getting best-in-class service. Just connect the USB device into your laptop and enjoy broadband speeds!

- Surf, email and download music at speeds of up to 10Mbps
- Use either Windows or Mac without any installation required—just plug 'n play

*\*4G network speed claim based on field comparison of avg. download speeds for CBW, AT&T, Sprint and T-Mobile conducted April 2011. Actual speeds may vary. 4G not available in all areas.*

### QUICK TIP

Call Cincinnati Bell at 1-888-391-3925 to set up international roaming before you travel abroad.



## Bundled Services

The easiest way to save a bundle with Cincinnati Bell is to bundle our services. And the more services you add, the bigger your savings will be. So add wireless to your Fioptics TV, Fioptics Internet or Fioptics Voice service to seize the absolute best possible deal.

## Coverage Map

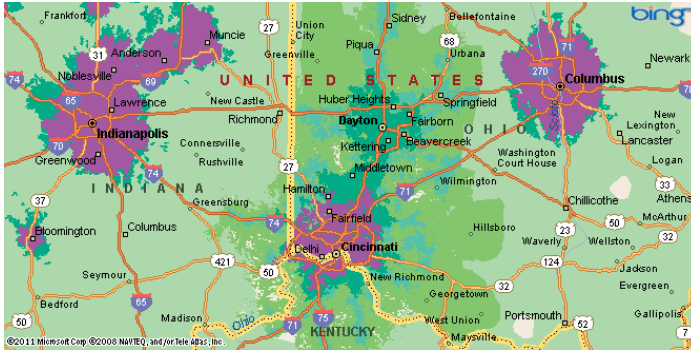

### Map Legend

- 4G coverage
- 3G coverage
- Local service area 2G best coverage
- Local service area 2G coverage
- National service area 2G coverage

## Phones

With over 30 wireless phones to choose from, you can find the phone that fits your style and your life.

### HTC Panache

#### Capabilities:

- Runs Android 2.3 OS
- Built-in Bluetooth v2.1 with EDR
- 8GB microSD card
- GPS with navigation capability
- Music player
- FM radio
- Full HTML with Android browser
- 5.0-megapixel camera with LED flash and autofocus

#### Display:

- 3.8-inch WVGA capacitive touchscreen (480 x 800)
- Multi-touch screen

#### Battery:

- Li-ion 1400 mAh battery (included in box)
- Up to 6 hours of talk time

### QUICK TIP

Monitor your wireless usage with Minute Tracker. Go to [cincinnatibell.com](http://cincinnatibell.com) and click on **My Account** to view call activity and set usage alerts.



# Support help when you need it

From payment support to troubleshooting and frequently asked questions, we're here to help. If you can't find the answer you need, call us or visit us online.

## My Account

Free online access is available round-the-clock, which makes reviewing your account information or making changes fast, secure and easy. Plus, you'll find a wealth of support information and online tours to guide you. To sign up, go online to [www.cincinnati-bell.com/fioptics](http://www.cincinnati-bell.com/fioptics) and click on **Manage My Account**.

- My Services
- My Notifications
- My Profile
- My Bills
- My Orders
- Order PPV

## eBill

eBill is our convenient paperless billing solution that makes paying your Cincinnati Bell bill simple and hassle-free. And best of all—it's FREE.

- Eliminate paper bills and trips to the mailbox
- Receive a courtesy email when your bill is available
- Access to up to 18 months of past bills online
- View your account online at your convenience, 24/7

## Autopay

Autopay is the simple, secure and worry-free way to pay your bill every month. Choose which checking account you want to use and indicate the due date on your statement, and on that day your bill will be paid automatically!

- No checks to write
- No late payments
- No stamps to buy
- No trips to the post office

Free up your time for more important things. And Autopay works perfectly, whether you prefer a paper or an electronic statement. It couldn't be any easier.

### QUICK TIP

If you have questions about your bill, log on to My Account to access online billing tutorials.



## Troubleshooting



### What if I am not receiving the HD-quality picture I expected?

Refer to the Interactive Program Guide (IPG) to determine if the program is broadcast in HD. If there are black bars to the right and left of the picture, in most instances your broadcaster is not transmitting in full HD. If you would like to have your picture fill the entire screen, refer to your TV manual for details.



### What do I do if I am getting poor reception or the picture on the TV screen is distorted?

Make sure that the set-top box is connected directly to the cable outlet. Reconnect and hand-tighten any loose cables. Verify that your TV is tuned to the appropriate input.



### What do I do if my IPG is frozen?

Reset your set-top box. Unplug the box, wait a few seconds, then plug it back in. Please note, it may take a few minutes for the software to update and the IPG to become operational again.



### Why can I see a picture but can't hear any sound?

Make sure  hasn't been pressed and try turning up the volume. Verify that the cables attached to the audio input jacks on the back of your set-top box and your TV or home theater system have been properly attached and are tight.



### What do I do if there is no video picture on the TV screen?

Make sure that your TV, set-top box and home theater system are powered on, and that your remote is set to the appropriate input source. Ensure that the cables are connected correctly and hand-tighten any loose connections. Tune to an authorized cable channel (one that you know that you get).



### What does the "account is locked" error message mean?

Your email is currently being accessed. Double check to make sure that no one else or no other program is trying to check the same email account at the same time. Please note: you might see this error message if you leave your email running at home and then try to check your email from another location. If you are certain that no other program or person is trying to check your email, then shut down your email and leave it off for at least 15 minutes before trying again. If you still receive the same error message after rebooting, please contact Cincinnati Bell's customer service department.



### Why can I load some web pages but not others?

Typically, this means that the server hosting the web page you're trying to access may be down or that the web page has moved. Verify that you have the correct URL. Alternately, the web page you're trying to access may be too busy. Wait a few minutes then reload the web page.



## Legal: Cincinnati Bell Extended Territories LLC

### SCHEDULE OF RULES AND REGULATIONS FOR CABLE TELEVISION SERVICE

YOUR USE AND ACTIVATION OF THE SERVICE SHALL CONSTITUTE AN ACCEPTANCE OF THE TERMS BELOW. IF YOU DO NOT ACCEPT THE TERMS AND CONDITIONS DO NOT INSTALL AND/OR ACTIVATE THE SERVICE.

#### APPLICATION FOR SERVICE

The Subscriber shall submit a written application for cable service for each location where service is desired on forms provided by Cincinnati Bell.

#### PROVISION OF SERVICE

CINCINNATI BELL shall make every reasonable effort to provide CATV service to every Subscriber who applies for such service in the shortest period of time practicable, and where CATV service is readily available. CINCINNATI BELL's CATV services will only be extended into areas where CINCINNATI BELL is duly authorized to provide service by the relevant franchising authority.

#### FEES AND CHARGES

Upon acceptance by CINCINNATI BELL of the Subscriber application for CATV service, the Subscriber shall pay to CINCINNATI BELL the applicable monthly service fee, all security deposits, any equipment lease fees or purchase costs, installation fees, connection fees, and any other fees or charges due CINCINNATI BELL. Any service, lease maintenance, purchase, installation, security deposits, and other charges for which the Subscriber is obligated shall be payable in advance. There is a minimum of thirty (30) days charged for each service provided.

#### OWNERSHIP OF EQUIPMENT AND MATERIALS

All equipment and materials, unless purchased from CINCINNATI BELL, or unless such property is incorporated in, becomes an integral part of, or is permanently attached to the Subscriber's premises shall remain the property of CINCINNATI BELL.

#### RESPONSIBILITY FOR CINCINNATI BELL'S PROPERTY

The Subscriber agrees not to tamper with any of CINCINNATI BELL's wiring or equipment, to extend lines, or alter in any manner any CINCINNATI BELL property. The Subscriber also shall receive CINCINNATI BELL's CATV service with the understanding that he will adequately safeguard all CINCINNATI BELL properties upon the Subscriber's premises from alteration and abuse by others, and that he will not hire or permit anyone other than authorized CINCINNATI BELL personnel to perform any work on CINCINNATI BELL's property, equipment, and facilities.

#### EQUIPMENT RETURN

Whenever service is terminated, the Subscriber shall return any equipment to CINCINNATI BELL's office. If the returned equipment is received by CINCINNATI BELL and is found to be in satisfactory working condition, and Subscriber has paid all service charges and any other applicable fees or charges, Subscriber shall be entitled to the original amount of the deposit for the equipment, without interest or earnings. If the returned equipment is received by CINCINNATI BELL and is not found to be in satisfactory working condition, or if said equipment has been opened, tampered with, defaced, or damaged (normal wear and tear excepted) said equipment deposit shall not be returned to the Subscriber but shall be retained by CINCINNATI BELL and applied toward the cost of its repair or replacement. The Subscriber understands, notwithstanding any other provision contained in these rules and regulations to the contrary, that any equipment provided is and shall remain the property of CINCINNATI BELL, and must be returned to CINCINNATI BELL at any time service is terminated or discontinued. Failure to return equipment within fifteen (15) days after service is terminated or discontinued will result in a charge being assessed to Subscriber's account.

#### WIRING REQUIREMENTS

No wiring will be installed by CINCINNATI BELL within any wall or attic space unless specifically requested by Subscriber and agreed to by both parties. The Subscriber, at his option, may choose to install the wiring within walls and/or attic spaces at his own expense. In such instance, the Subscriber shall install such wiring to specifications and satisfaction of CINCINNATI BELL and the National Electrical Code.

If Subscriber does not own the premises at which service is to be installed, Subscriber represents that he has obtained necessary permission from the premise owner to install CINCINNATI BELL's equipment (including, without limitation, equipment attached to the outside of the premises). Subscriber further agrees to indemnify CINCINNATI BELL from all claims of the owner in connection with the installation and provision of services.

#### RIGHT OF ACCESS

The Subscriber, upon acceptance of application for CATV service by CINCINNATI BELL, grants permission for CINCINNATI BELL, its agents and employees, to enter upon the property of the Subscriber for the purpose of installation, inspection, maintenance, testing, and repair of the cable service to the Subscriber's premises and, upon service being cancelled for any reason, the Subscriber grants permission for CINCINNATI BELL, during reasonable hours, to enter upon the premises and remove all equipment and material belonging to CINCINNATI BELL and to discontinue service thereto.



## **WARRANTIES AND REPAIRS OF CINCINNATI BELL EQUIPMENT**

CINCINNATI BELL will repair and/or replace defective equipment (excluding the replacement of batteries) as long as such damage was not caused by misuse or other improper operations or handling by Subscriber. CINCINNATI BELL is not responsible for the maintenance or repair of Subscriber provided equipment, including but not limited to television sets, VCRs or other video equipment, remote controls, keyboards, stereos or other audio equipment, telephones or A/B switches. A service charge may be imposed if damage to CINCINNATI BELL Equipment is due to negligent use or abuse or if no fault is discovered in System or Equipment. In addition, an equipment charge may be imposed for the repair or replacement of any lost, stolen or damaged Equipment. CINCINNATI BELL makes no warranties, with respect to equipment or service provided by CINCINNATI BELL or with respect to the Equipment compatibility with any Subscriber-owned equipment.

## **PENALTIES FOR UNAUTHORIZED SERVICE**

If unauthorized service is discovered by Cincinnati Bell, the cost will be billed to the Subscriber for an estimate of CATV services delivered, including the cost of inspection, investigation, reconnection, and cost of repair to CINCINNATI BELL's facilities, all of which must be paid in full before service can be reestablished or restored.

## **MONTHLY SERVICE CHARGES**

The Subscriber shall pay CINCINNATI BELL a one-time pro-rated monthly service charge from date of installation to the end of that billing cycle. Thereafter, the Subscriber shall pay CINCINNATI BELL the full monthly service charge applicable to the services rendered, which amount shall be due as shown on the monthly billing statement. Late payments are subject to a 1.5% late payment penalty. Failure to pay charges invoiced may result in discontinuance of service in Accordance with Subsection 12, below.

Monthly service charges are subject to change at any time, although CINCINNATI BELL will provide Subscriber at least thirty (30) days advance, written notice before instituting an increase in service rates.

## **DISCONNECTION OF SERVICE**

CINCINNATI BELL may suspend and/or disconnect service for nonpayment of undisputed monthly service charges that are not paid in full by the due date shown on the bill. CINCINNATI BELL will provide customer with a minimum of ten (10) days advance, written notice of a disconnection of all or part of the Subscriber's service, except where disconnection has been requested by the Subscriber, is necessary to prevent theft of service, or is necessary to reduce or prevent signal leakage as described by 47 CFR § 76.61. CINCINNATI BELL will not disconnect all or part of a Subscriber's service for nonpayment until the bill is at least forty five (45) days past due.

## **PREMIUM / PAY-PER-VIEW SERVICE**

The new Subscriber may elect to receive premium service only after he has submitted an application for digital service and premium service. An existing digital service Subscriber can elect to receive premium service by submitting his application for such service, but in no instance will any Subscriber be permitted to receive premium service without CINCINNATI BELL's digital service or if Subscriber has a past due account.

The Subscriber may also elect to receive pay-per-view events and/or movies from time to time; however, in no instance will a Subscriber be permitted to receive this service if an amount is shown to be past due on the Subscriber's account. In addition, no refund for any pay-per-view event/movie will be granted after the initial ten (10) minutes of the event/movie has been received by Subscriber.

## **CHANGE OF OCCUPANCY OR OWNERSHIP**

The Subscriber shall notify CINCINNATI BELL of any change of occupancy or ownership of Subscriber's premises promptly upon its occurrence. Nothing in these rules and regulations shall be construed to give the Subscriber the right to sell or assign, or the successor tenant or occupant to acquire, any rights to use any of the equipment or service provided by CINCINNATI BELL.

## **LIMITATION OF CINCINNATI BELL'S LIABILITY**

CINCINNATI BELL, its agents or employees, shall not be held liable or responsible for any damage or injury to the property of the Subscriber occurring during installation or maintenance of facilities including, but not limited to, outlet, cable, connector, etc., to provide and/or maintain service to Subscriber.

## **DISCLAIMER REGARDING PROGRAMMING CONTENT OR CHANGES**

The Subscriber shall not hold CINCINNATI BELL responsible nor liable for programming content, nor for any changes, additions, or deletions in its programming or time schedule associated therewith. CINCINNATI BELL shall give Subscriber at least thirty (30) days advance, written notice before removing a channel from the programming lineup except if such removal is caused by circumstances beyond CINCINNATI BELL's control.

## **SCOPE**

A copy of the rates, rules and regulations under which CATV service will be supplied is open to inspection by the general public at the office of CINCINNATI BELL. A hard copy of CINCINNATI BELL's rules and regulations and applicable rate schedule shall be furnished to each Subscriber without charge, upon request.



## **INTERRUPTION OR DISCONTINUANCE OF SERVICE DUE TO USE OF NON-CINCINNATI BELL FACILITIES**

In order to provide service, CINCINNATI BELL shall occasionally make use of poles owned in whole or in part by other utilities, both power and telephone, the continued use of which is in no way guaranteed. In the event the continued use of such poles is denied for any reason, Cincinnati Bell will make every reasonable effort to provide service over alternative routes and facilities. The Subscriber agrees that he will make no claims or undertake any action against any utility, including CINCINNATI BELL, if the service provided to the Subscriber is interrupted or discontinued for this reason.

## **LOCATION OF OVERHEAD FACILITIES**

Unusual circumstances to the contrary, CINCINNATI BELL's overhead CATV service drop to the Subscriber premises shall be located as closely to the point of electrical service attachment as is safe and practicable.

## **OUTAGES & INTERRUPTIONS**

CINCINNATI BELL will restore CATV service to its Subscribers within seventy-two (72) hours after a Subscriber reports a service interruption or other problem when such problem is found to be the fault of CINCINNATI BELL's system and/or equipment, provided the cause is not a natural disaster. If the service interruption is caused by CINCINNATI BELL and lasts for more than four (4) hours in a given twenty-four (24) hour period, CINCINNATI BELL will give the Subscriber a credit for each day that the Subscriber is without service.

In the event CINCINNATI BELL dispatches any of its personnel to investigate any Subscriber complaint or outage, and the problem is determined to be caused by the Subscriber's television receiver or other Subscriber-owned facilities, the Subscriber may be charged the cost of time and transportation, but in no event shall said charge be less than \$14.95.

## **REPRODUCTION OF PROGRAMMING**

The Subscriber shall not record or tape any of the programming provided by CINCINNATI BELL, nor shall the Subscriber allow any other person to do so, except for the personal use of the Subscriber. Subscriber agrees that the programs and other services provided by CINCINNATI BELL will be utilized solely for Subscriber's personal, non-commercial use and will not be duplicated except in compliance with applicable law.

## **SEVERABLE PROVISIONS**

In the event any portion of these rules and regulations should be declared invalid by any court of competent jurisdiction, such invalidity shall not affect the remaining portions hereof, which shall continue effective.

## **PRIVACY**

CINCINNATI BELL agrees to follow the guidelines established by the Federal Communications Commission with respect to Subscriber privacy. You acknowledge receipt of the CBET Cable Subscriber Privacy Policy, which is deemed a part of this Agreement, and you expressly consent to the collection, use and disclosure of personally identifiable information as described in the Cable Subscriber Privacy Policy, as it may be amended from time to time.

The Cable Communications Policy Act of 1984 (the "Cable Act") requires us to inform you about Cincinnati Bell Extended Territories LLC's ("CBET") practices regarding personally identifiable information that may be collected in the course of providing services to you over our cable system, including video programming.

Under the Cable Act, you are entitled to know:

- The nature of the personally identifiable information we collect and the way we use this information
- Under what circumstances we may disclose personally identifiable information and to whom
- How long we maintain personally identifiable information
- How you may obtain access to your personally identifiable information
- Your rights under the Cable Act concerning personally identifiable information

## **I. COLLECTION AND USE**

### **What is personally identifiable information?**

Personally identifiable information is information that identifies a particular person. It does not include aggregate data that does not identify a particular person. This notice addresses the personally identifiable information that you have furnished to us or that we have collected using the CBET cable system when we provide video programming or other services to you.

### **What kind of personally identifiable information does CBET collect?**

Under the Cable Act, CBET is only permitted to collect personally identifiable information for the following purposes:

- in order to obtain information necessary to provide our cable service or other services to you;
- and to detect unauthorized reception of cable communications.

The Cable Act prohibits us from using our cable facilities to collect personally identifiable information about you for any other purpose without your prior written or electronic consent.

In order to provide reliable, high quality service to you with minimal delays, we keep business records containing information about you that may constitute personally



identifiable information. The personally identifiable information we collect typically includes the following:

- name
- address
- telephone number
- e-mail address
- driver's license number
- Social Security number
- credit card and/or bank account number
- other similar account information

We may also collect other information about your account including billing, payment, and deposit history; past correspondence with you; maintenance and complaint information; information about the services to which you subscribe and your use of those services; information about the purchases you make over the system; and records indicating the types and number of devices you use to connect to the system (e.g., televisions, modems, set-top boxes, and computers). Additionally, if you rent your residence, we may have a record of whether landlord permission was required to install our cable service facilities as well as your landlord's name and address.

#### **What kind of information do you collect if I use interactive or transactional services?**

When you use our interactive or other transactional television services such as Video On Demand programming, our system automatically collects certain information on your use of these services. Most of this information is not personally identifiable information and is simply used to carry out a particular command or request you make using your remote control or set-top box. This may include information required to change your television channel, review listings in an electronic program guide, and pause or fast-forward through certain On Demand programs, among other information. It may also include other information such as the specific service features you use and the time spent using them. However, in order to carry out a request to watch a pay-per-view program or Video On Demand, for example, the CBET's system may collect certain personally identifiable information, such as your account information, in addition to the product or service purchased, so that you may be properly billed for the program or service.

#### **How does CBET use personally identifiable information?**

CBET collects, maintains, and uses personally identifiable information as permitted by the Cable Act and other applicable laws. Generally, we use this information to conduct business activities related to providing cable and other services to you and to help us detect theft of service. More specifically, we use personally identifiable information for the following business purposes:

- To ensure that you are receiving the services you ordered
- To allow us to properly maintain those services and to make improvements or upgrades when necessary

- To confirm that you are being properly billed
- To provide you with technical support and for system maintenance
- To inform you of new products or services that may be of interest to you
- To allow us to understand the use of, and identify improvements to, our services
- To prevent fraud, including the unauthorized use of our service or violations of applicable policies and terms of service
- To ensure our own compliance with the law

Additionally, we may use or disclose personally identifiable information about you without your consent to protect our customers, employees, or property, in emergency situations, to enforce our rights under our terms of service and policies, in court or elsewhere, and as permitted by law.

## **II. DISCLOSURE**

#### **Does CBET disclose personally identifiable information to others?**

CBET considers the personally identifiable information contained in our business records to be confidential. We are, however, authorized under the Cable Act to disclose personally identifiable information if the disclosure is:

- necessary to provide or conduct a legitimate business activity related to the cable service or other services provided over our facilities,
- required, as required by law or legal process, or
- of the names and addresses of subscribers for "mailing lists" or other purposes (described below).

We may disclose personally identifiable information to other parties (such as our affiliates, vendors, and agents) when it is necessary to conduct a legitimate business activity related to the cable service or other services we provide to you. For example, we may engage such parties to assist us in billing and collections, administration, surveys, marketing, service delivery and customization, maintenance and operations, and fraud prevention. We may also disclose personally identifiable information about you to outside auditors and regulators. We may also collect, use, and disclose information in non-personally identifiable or aggregate formats, such as ratings surveys and service usage and other statistical reports, which do not personally identify you, your particular viewing habits, or any transaction you have made over our system. The frequency of our disclosure of personally identifiable information depends upon the particular business needs activity for which it is disclosed.

Similarly, if we (or our parent company) enter into a merger, acquisition, or sale of all or a portion of our assets, subscribers' personally identifiable information will, in most instances, be transferred as part of the transaction.



The Cable Act also authorizes CBET to disclose limited personally identifiable information to others including charities, marketing organizations, or other businesses for cable or non-cable "mailing list" or other purposes. Any "mailing list" or related disclosure that we may make is limited to disclosure of your name and address. Such information does not reveal the extent of any viewing or use of cable or other services or the nature of any transaction made over our cable system. However, before we make such mailing list information available to others, CBET will provide you with notice and an opportunity to contact us to prohibit or limit such disclosure.

#### **When is CBET required to disclose personally identifiable information by law?**

We make every reasonable effort to protect our subscriber's privacy as described in this notice. However, we may be required by law to disclose personally identifiable information about a subscriber without his or her consent and without notice in order to comply with a valid legal process such as a subpoena, court order, or search warrant.

The Cable Act may require that we disclose personally identifiable information to a third party or governmental entity in response to a court order or other legal process. If a court order is sought by a non-governmental entity, we are required to notify you of the court order and your opportunity to appear in court and contest the order. If the court order or other legal process is sought by a governmental entity, the Cable Act requires that we disclose the information to the government unless the records sought involve your video programming selections, in which case you will be given the opportunity to appear and contest any claims made in support of the court order or legal process.

#### **Can I limit or prohibit CBET's use of my personally identifiable information?**

You may contact CBET at the customer care number referenced on your bill to ask us to put you on our "Do Not Call" or "Do Not Mail" lists so that you do not receive marketing or promotional telephone calls or mail from us or our agents.

#### **How does CBET protect personally identifiable information?**

We follow industry-standard practices to take such actions as are necessary to prevent unauthorized access to personally identifiable information by a person other than the subscriber or us. However, we cannot guarantee that these practices will prevent every unauthorized attempt to access, use, or disclose personally identifiable information.

#### **How long does CBET maintain personally identifiable information?**

CBET maintains personally identifiable information about you in our regular business records while you are a subscriber to out cable or other services. We may also maintain this information for a period of time after you are no longer a subscriber if it is necessary for business, legal, or tax purposes. We will destroy the information if we have no pending requests, orders, or court orders for access to this personally identifiable information, after

we determine that it is no longer necessary for the purposes for which it was collected and in compliance with any local requirements.

### **III. CUSTOMER CHOICE AND ACCESS**

#### **Where and when can I see my personally identifiable information?**

If you would like to see your personally identifiable information, please send us a written request to the correspondence address listed in the "Contact Us" section of your bill. We will be glad to arrange a convenient time and location during regular business hours for you to see the information upon furnishing proper identification. You will only be permitted to examine records that contain personally identifiable information about you and no one else. If you believe any of your personally identifiable information is inaccurate, we will work with you to ensure that the appropriate corrections are made. CBET reserves the right to charge you for the cost of photocopying any documents that you request.

#### **What can I do if I think my privacy rights have been violated?**

CBET takes your privacy rights very seriously. If you believe that your privacy rights have been violated, please contact us immediately. We will take immediate steps to address your concerns. You may enforce the limitations imposed on us by the Cable Act through a civil lawsuit seeking damages, attorney's fees, and litigation costs. Other rights and remedies may be available to you under federal or other applicable laws as well.

#### **Does this notice apply to CBET's Internet service or voice service?**

If you are a subscriber to CBET's ZoomTown service, a description of our privacy practices may be found at [http://www.cincinnatiBell.com/customer\\_support/policies/zoomtown/](http://www.cincinnatiBell.com/customer_support/policies/zoomtown/).

If you are a subscriber to CBET's voice service, our privacy practices are described in CBET's CPNI Policy for telecommunications services. That policy is available at <https://my.cincinnatiBell.com/SelfCare/UI/Root/Unauthenticated/CPNI.aspx>. CBET's Do Not Call Policy can be found at [http://www.cincinnatiBell.com/customer\\_support/policies/do\\_not\\_call\\_policy/](http://www.cincinnatiBell.com/customer_support/policies/do_not_call_policy/).

#### **Will CBET notify me if it changes this notice?**

As required by the Cable Act, we will provide you with a copy of our subscriber privacy notice on an annual basis. We may modify this notice at any time. We will notify you of any material changes through written, electronic, or other means as permitted by law. You may cancel your service at any time if you do not agree to any change. By continuing to use the service after a change is in effect, you accept the change and agree to abide by it.



## Contact Us

### Store Locations

- Deerfield Township  
5325 Deerfield Blvd.  
Mason, OH 45040
- Eastgate Mall  
4601 Eastgate Blvd.  
Cincinnati, OH 45245
- Tri-County  
11332 Princeton Pike  
Cincinnati, OH 45246
- Atrium One (Lobby)  
201 E. 4th St.  
Cincinnati, OH 45202
- Western Hills  
5098 Glencrossing Way  
Cincinnati, OH 45238
- West Chester Plaza  
7842 Cox Rd.  
West Chester, OH 45069
- Kenwood  
7565 Kenwood Rd.  
Cincinnati, OH 45236
- Hyde Park Plaza  
3880 Paxton Ave.  
Cincinnati, OH 45209
- Florence Mall  
2028 Florence Mall Rd.  
Florence, KY 41042
- Crestview Hills Town Center  
2895 Dixie Hwy.  
Crestview Hills, KY 41017
- Bridgewater Falls  
3425 Princeton Rd., Suite C-119  
Hamilton, OH 45011
- Northgate Mall  
9597 Colerain Ave.  
Cincinnati, OH 45251

### Telephone Numbers

- Sales & Support: 513-565-9890
- Sales & Support (Lebanon): 513-933-7201

*If you have a question that was not answered in this book, please contact us or visit [www.cincinnati-bell.com/fioptics](http://www.cincinnati-bell.com/fioptics).*

